

### Features

- One-piece toilets integrate the tank and bowl into a seamless, easy-to-clean design.
- Round-front bowl offers an ideal solution for smaller baths and powder rooms.
- Low-profile design.
- 1.28 gpf (4.8 lpf).
- Standard left-hand trip lever included.
- Includes K-4009 Reveal® Quiet-Close™ with Grip-Tight seat.

### Technology

- Single-flush gravity uses the force of gravity and a precision-engineered tank, bowl, and trapway to create a strong siphon during flushing.
- AquaPiston® canister allows water to flow into the bowl from all sides (360 degrees), increasing the power and effectiveness of the flush.
- Flush valve's 3:2 ratio harnesses the natural force of gravity and optimizes flush performance.
- Durable canister design has 90% less exposed seal material than a 3" flapper for leak-free performance.
- Light-touch canister flush requires a lower actuation force than a flapper.

### Installation

- Standard 12" (305 mm) rough-in.
- Supply line sold separately.

### Water Conservation & Rebates

- Eligible for consumer rebates in some municipalities.

### Recommended Products/Accessories

K-75758 Cachet® Nightlight Quiet-Close™ Round-Front Toilet Seat  
 K-76923 Puretide™ Quiet-Close™ Round-front manual cleansing toilet seat  
 K-5420 Low-Profile Bolt Caps  
 K-9176 Trip Lever  
 1023457 Wax Ring/Hardware Kit  
 1265114 Connector Hose  
 K-23726 Drain treatment

### Included Components

Additional Components:  
 Bolt cap accessory pack  
 Tank Accessory Pack  
 Tank Cover  
 Trip Lever



### Codes/Standards









ASME A112.19.2/CSA B45.1  
 DOE - Energy Policy Act 1992  
 EPA WaterSense®

### KOHLER® Toilets and Seats Limited Warranty

See website for detailed warranty information.

### Available Colors/Finishes

*Color tiles intended for reference only.*

Color	Code	Description
	0	White
	96	Biscuit
	47	Almond
	NY	Dune
	95	Ice™ Grey
	G9	Sandbar
	K4	Cashmere
	58	Thunder™ Grey
	7	Black Black™

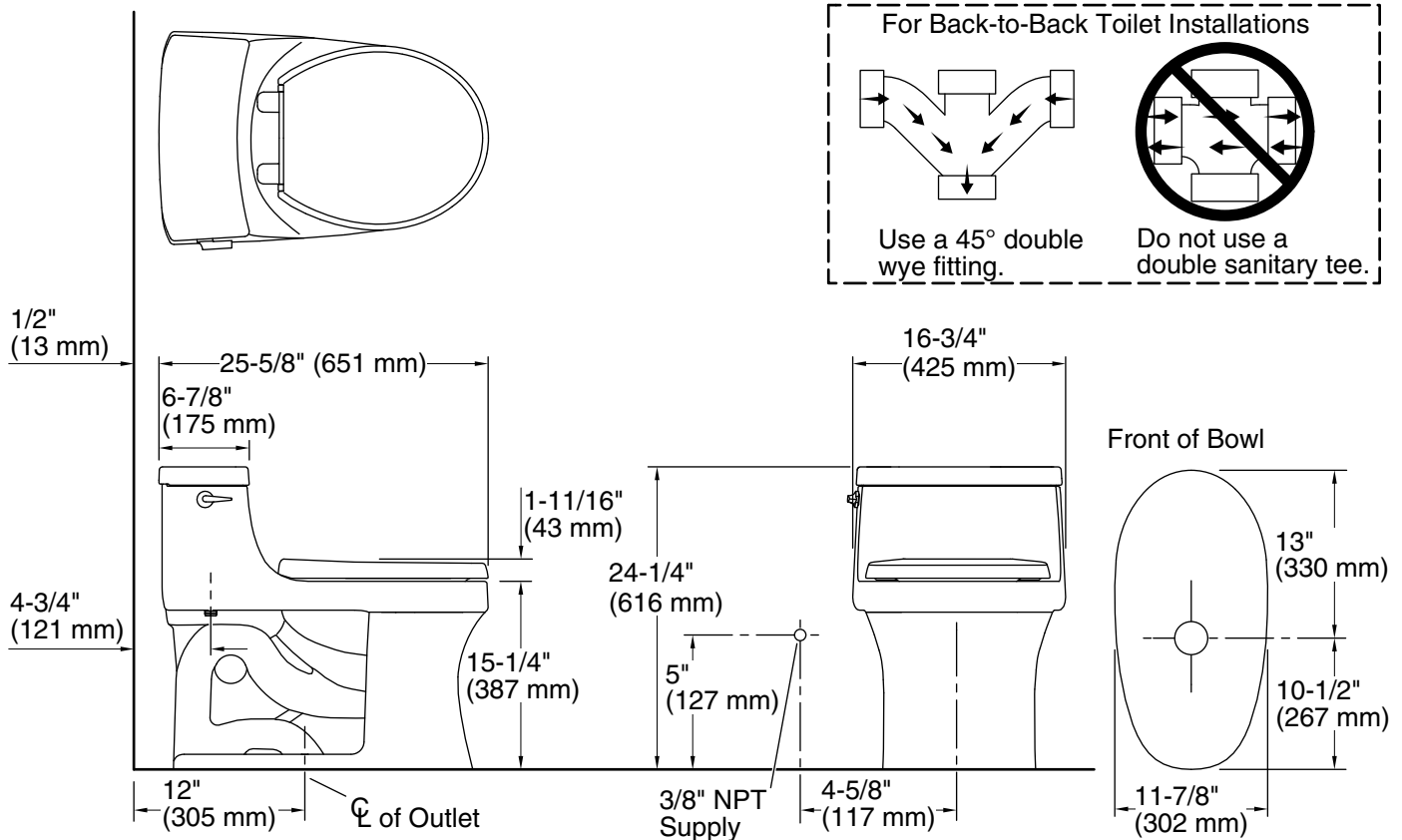

### Technical Information

All product dimensions are nominal.

Toilet type:	One-piece, Floor-mount
Waste Outlet:	Floor
Bowl shape:	Round-front
Flush type:	AquaPiston®
Trap passageway:	2-1/8" (54 mm)
Water Consumption	
Full:	1.28 gpf (4.8 lpf)
Water surface size:	9-1/4" x 6-3/4" (235 mm x 171 mm)
Rim to water surface:	6-5/16" (160 mm)
Rough-in:	12" (305 mm)
Seat-mounting holes:	5-1/2" (140 mm)

### Fixture Supply Requirements

Min static pressure:	20 psi (137.9 kPa)
Max static pressure:	80 psi (551.6 kPa)

### Notes

Install this product according to the installation instructions.

For back-to-back toilet installations: Use only a 45° double wye fitting.